

**BINKS® "TROPHY" SERIES AUTOMATIC SPRAY GUNS**  
HVLP, LVMP & CONVENTIONAL (3465-XXXX-XXXX)

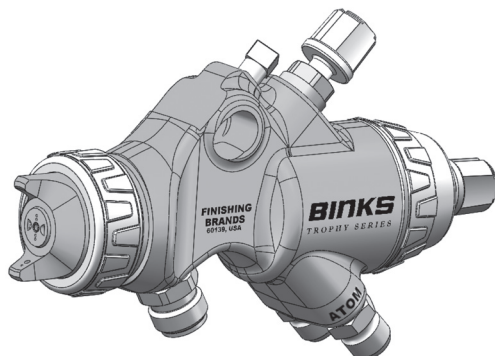

Binks Trophy Series Automatic Spray Gun is the premier spray gun for use in automatic spray applications, incorporating some of the best features of our Trophy hand spray gun. Trophy Automatic gun offers total control of atomizing air pressure, side port air, fluid flow, and spray patterns in high and low production settings. Latest advancements in atomization technology have been incorporated for achieving consistent, fine finishes when spraying a wide range of industrial coatings.

All product contact surfaces are manufactured from FDA acceptable materials when using a 45-11050-XX, 45-11060-XX series fluid nozzle and a 47-6860, 47-6864, 47-6865, 47-6866 needle.

Binks Trophy Automatic Series Spray Guns can be used with pressure pots and pumps.

Binks Trophy Series Spray Guns are offered in three different atomization technologies: HVLP, LVMP and Conventional.

**SPECIFICATIONS**

Maximum Air Pressure	140 psi / 9.6 bar (P-1)
Maximum Fluid Pressure	140 psi / 9.6 bar (P-2)
Gun Body	Anodized Aluminum
Cylinder Air Pressure to Operate the Gun	65 psi / 4.5 bar
Fluid Path	Stainless Steel
Fluid Inlet Size	3/8" NPS / BSP(m)
Air Inlet Size	1/4" NPS / BSP(m)
Gun Weight	20.8 oz. / 590 grams
Wetted Parts	Stainless Steel & UHMWPE
Gun Mounting Hole	1/2" diameter

**The Trophy HVLP Series of Spray Guns can be used to operate at high transfer efficiencies in compliance with "California South Coast Air Quality Management District" regulations as a High Volume, Low Pressure spray gun.**

**IMPORTANT! DO NOT DESTROY**

**It is the customer's responsibility to have all operators and service personnel read and understand this manual. Contact your local Binks representative for additional copies of this manual.**

**READ ALL INSTRUCTIONS BEFORE OPERATING THIS BINKS PRODUCT.**

**Product Description/Object of Declaration:** Trophy

**This Product is designed for use with:** Solvent and Water based Materials, Food, Pharmaceutical

**Suitable for use in hazardous area:** Zone 1 / Zone 2

**Protection Level:** II 2 G X

**Notified body details and role:** TRAC Global Ltd (0891)  
Lodging of Technical file

**This Declaration of Conformity  
/incorporation is issued under the sole  
responsibility of the manufacturer:** Carlisle Fluid Technologies,  
320 Phillips Ave.,  
Toledo, OH 43612

## EU Declaration of Conformity



**The object of the declaration described above is in conformity with the relevant Union harmonisation legislation:**

Machinery Directive 2006/42/EC  
ATEX Directive 2014/34/EU

by complying with the following statutory documents and harmonized standards:

EN ISO 12100:2010 Safety of Machinery - General Principles for Design

BS EN 1953:2013 Atomising and spraying equipment for coating materials - Safety requirements

EN 1127-1:2011 Explosive atmospheres - Explosion prevention - Basic concepts

EN 13463-1:2009 Non electrical equipment for use in potentially explosive atmospheres - Basic methods and requirements

Providing all conditions of safe use / installation stated within the product manuals have been complied with and also installed in accordance with any applicable local codes of practice.

Signed for and on behalf of  
Carlisle Fluid Technologies:

DJ Hasselschwert  
11-Jul-16

(Vice President: Global  
Product Development)

Toledo, OH 43612

Binks reserves the right to modify equipment specification without prior notice.

In this part sheet, the words **WARNING**, **CAUTION** and **NOTE** are used to emphasize important safety information as follows:

**⚠ WARNING**

**Hazards or unsafe practices which could result in severe personal injury, death or substantial property damage.**

**⚠ CAUTION**

**Hazards or unsafe practices which could result in minor personal injury, product or property damage.**

**NOTE**

**Important installation, operation or maintenance information.**

**Read the following warnings before using this equipment.**



**READ THE MANUAL**

Before operating finishing equipment, read and understand all safety, operation and maintenance information provided in the operation manual.



**WEAR SAFETY GLASSES**

Failure to wear safety glasses with side shields could result in serious eye injury or blindness.



**DE-ENERGIZE, DEPRESSURIZE, DISCONNECT AND LOCK OUT ALL POWER SOURCES DURING MAINTENANCE**

Failure to De-energize, disconnect and lock out all power supplies before performing equipment maintenance could cause serious injury or death.



**OPERATOR TRAINING**

All personnel must be trained before operating finishing equipment.



**EQUIPMENT MISUSE HAZARD**

Equipment misuse can cause the equipment to rupture, malfunction, or start unexpectedly and result in serious injury.



**KEEP EQUIPMENT GUARDS IN PLACE**

Do not operate the equipment if the safety devices have been removed.

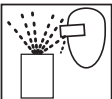

**PROJECTILE HAZARD**

You may be injured by venting liquids or gases that are released under pressure, or flying debris.



**PINCH POINT HAZARD**

Moving parts can crush and cut. Pinch points are basically any areas where there are moving parts.



**INSPECT THE EQUIPMENT DAILY**

Inspect the equipment for worn or broken parts on a daily basis. Do not operate the equipment if you are uncertain about its condition.



**NEVER MODIFY THE EQUIPMENT**

Do not modify the equipment unless the manufacturer provides written approval.



**KNOW WHERE AND HOW TO SHUT OFF THE EQUIPMENT IN CASE OF AN EMERGENCY**



**PRESSURE RELIEF PROCEDURE**

Always follow the pressure relief procedure in the equipment instruction manual.



**NOISE HAZARD**

You may be injured by loud noise. Hearing protection may be required when using this equipment.



**STATIC CHARGE**

Fluid may develop a static charge that must be dissipated through proper grounding of the equipment, objects to be sprayed and all other electrically conductive objects in the dispensing area. Improper grounding or sparks can cause a hazardous condition and result in fire, explosion or electric shock and other serious injury.



**FIRE AND EXPLOSION HAZARD**

Never use 1,1,1-trichloroethane, methylene chloride, other halogenated hydrocarbon solvents or fluids containing such solvents in equipment with aluminum wetted parts. Such use could result in a serious chemical reaction, with the possibility of explosion. Consult your fluid suppliers to ensure that the fluids being used are compatible with aluminum parts.



**PROP 65 WARNING**

**WARNING:** This product contains chemicals known to the State of California to cause cancer and birth defects or other reproductive harm.

**IT IS THE RESPONSIBILITY OF THE EMPLOYER TO PROVIDE THIS INFORMATION TO THE OPERATOR OF THE EQUIPMENT.**

**FOR FURTHER SAFETY INFORMATION REGARDING BINKS AND DEVILBISS EQUIPMENT, SEE THE GENERAL EQUIPMENT SAFETY BOOKLET (77-5300).**

**BINKS "TROPHY" SERIES SPRAY GUN**

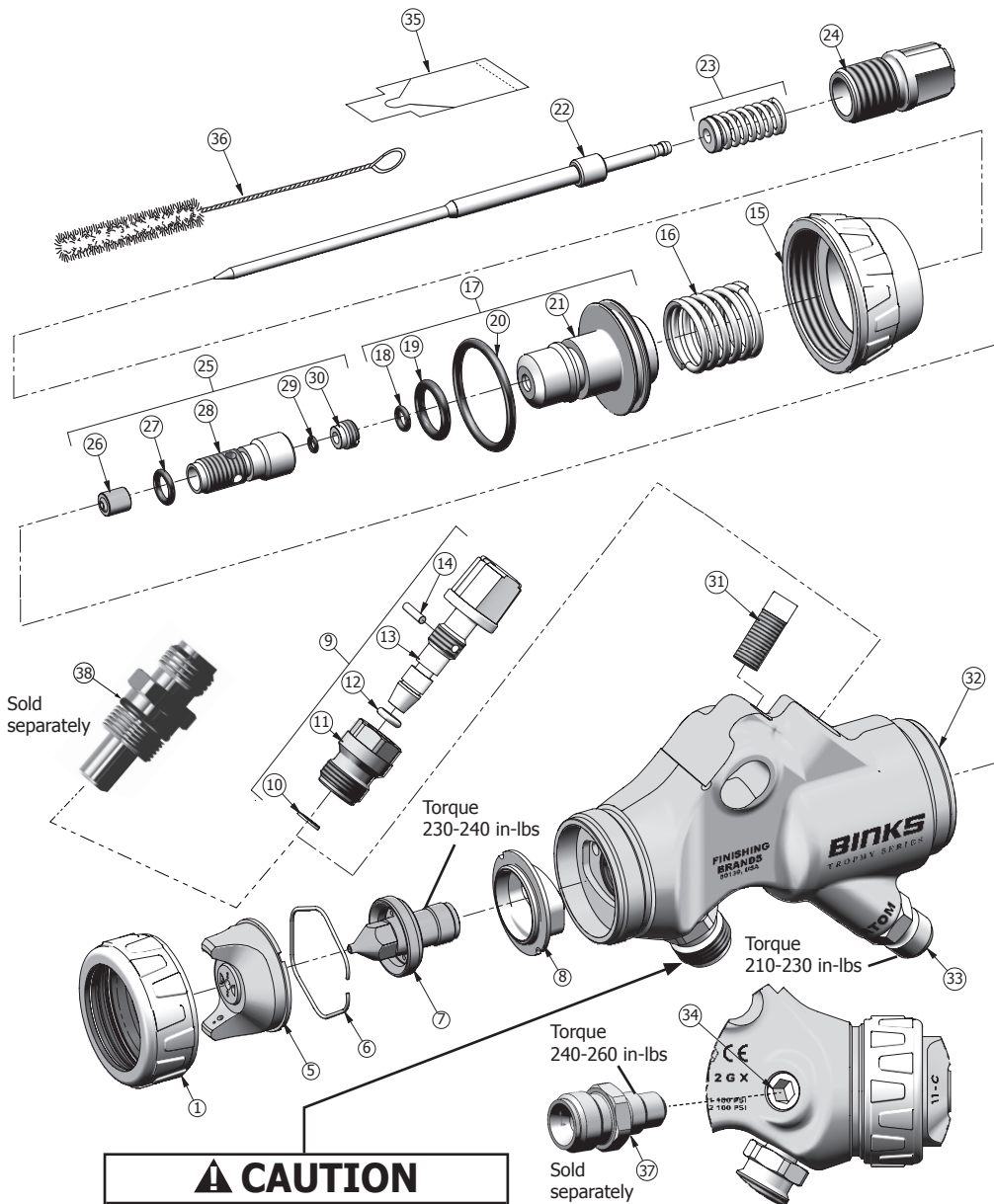

## CHART 1: BINKS "TROPHY" SERIES SPRAY GUN PARTS LIST

ITEM NO.	PART NUMBER	DESCRIPTION	QTY.
1	54-6120	AIR CAP RING ASSEMBLY	1
5	SEE CHARTS ON PAGE 11	AIR CAP	1
6	JGA-156-K10	SPRING-CLIP (KIT OF 10)	1
7	SEE CHARTS ON PAGE 11	FLUID NOZZLE	1
8	54-6102-K3	SEPARATOR / BAFFLE (KIT OF 3)	1
9	54-6313	SIDE PORT ASSEMBLY	1
10	-----	Δ SIDE PORT RETAINING CLIP	1
11	-----	SIDE PORT VALVE BODY	1
12	-----	Δ SIDE PORT O-RING, Ø 4.8 x 1.6	1
13	-----	SIDE PORT KNOB & STEM	1
14	-----	Δ SIDE PORT PIN	1
15	54-6312	PISTON CAP	1
16	54-6311	PISTON SPRING	1
17	54-6322	PISTON ASSEMBLY	1
18	-----	• O-RING, INSIDE PISTON	1
19	-----	• O-RING, OUTSIDE PISTON	1
20	-----	• O-RING, INSIDE PISTON	1
21	-----	PISTON	1
22	47-6860	NEEDLE, STAINLESS, MARKING: I (STANDARD)	1
	47-6861 PAGE 8	NEEDLE, TUNGSTEN CARBIDE, MARKING: II	1
	47-6862	NEEDLE, PLASTIC, MARKING: III	1
	SEE CHART 2 ON PAGE 8	NEEDLE, FEATHERING	1
23	54-6320-K3	□ SPRING / PAD NEEDLE ASSEMBLY (KIT OF 3)	1
24	54-6309	NEEDLE ADJUSTING KNOB	1
25	54-6319	PACKING CARTRIDGE ASSEMBLY	1
26	54-6318-K3	NEEDLE PACKING, GREEN (KIT OF 3)	1
27	-----	§ O-RING, OUTSIDE CARTRIDGE	1
28	-----	PACKING BODY	1
29	-----	§ O-RING, INSIDE CARTRIDGE	1
30	54-6315-K3	PACKING SCREW (KIT OF 3)	1
31	20-1359-1	SET SCREW, MOUNTING	1
32	-----	GUN BODY ASSEMBLY WITH INSERT	1
33	54-308	FITTING, AIR CONNECTION, 1/4" NPS	2
34	54-6317-K3	PLUG, RECIRCULATING FLUID INLET, 1/4" HEX (KIT OF 3)	1
35	-----	GUNNER'S MATE (3 CC BAG)	1
36	82-469	GUN BRUSH	1
37	54-6316	◇ RECIRCULATING FITTING, 3/8" NPS(F)	1
38	54-6158	◇ REMOTE FAN CONTROL FITTING ASSEMBLY, 1/4" NPS/BSPP(M)	1

Δ PARTS INCLUDED IN SIDEPORT KIT GTI-428-K5

• PARTS INCLUDED IN KIT 54-6327-K3

□ OPTIONAL, HEAVY DUTY SPRING 54-839 (No Spring pad required)

§ PARTS INCLUDED IN KIT 54-6328-K3

◇ OPTIONAL ITEM, PURCHASE SEPARATELY

**BINKS "TROPHY" SERIES AUTOMATIC SPRAY GUN**

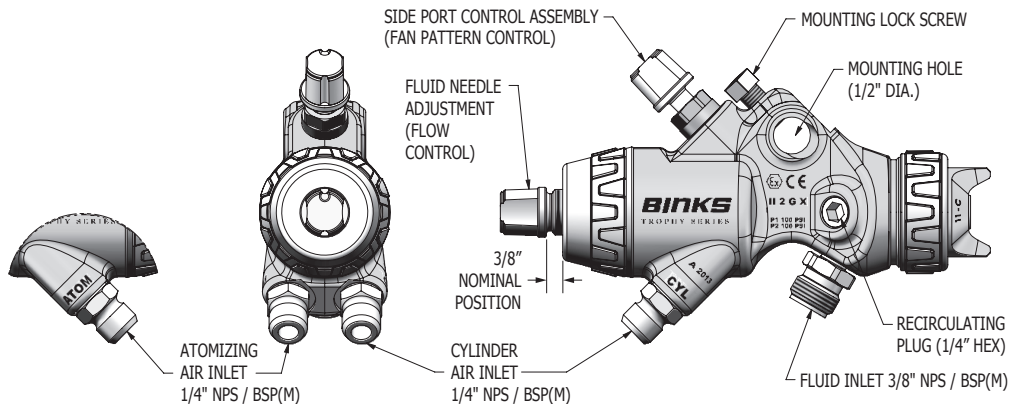

**BINKS "TROPHY" SERIES AUTOMATIC SPRAY GUN  
COMBINED FAN & ATOMIZING AIR  
(STANDARD SPRAY GUN HOOK-UP)**

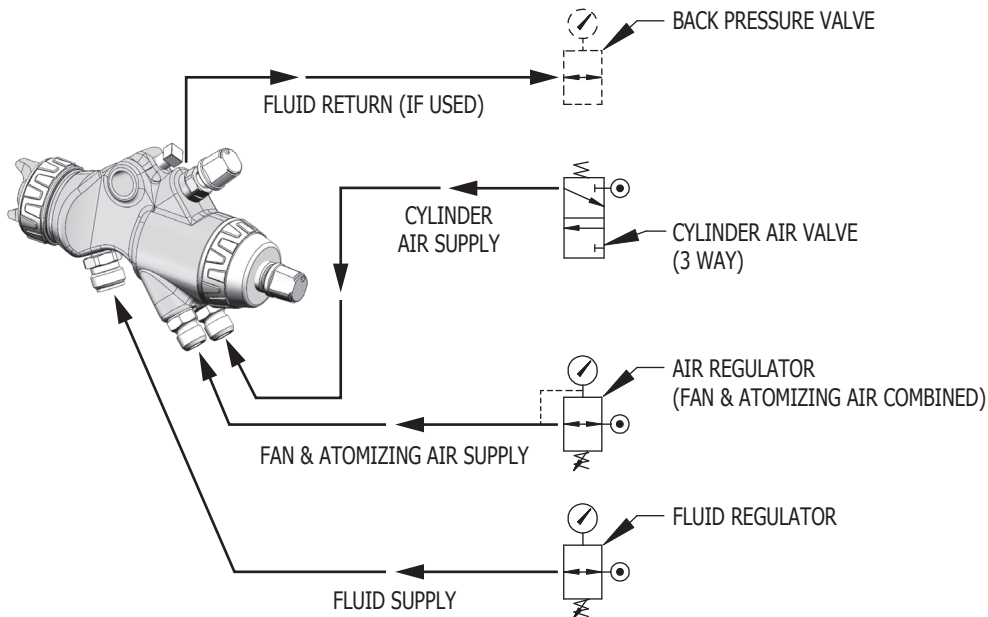

**BINKS "TROPHY" SERIES AUTOMATIC SPRAY GUN  
SEPARATE FAN & ATOMIZING AIR  
(OPTIONAL SPRAY GUN HOOK-UP)**

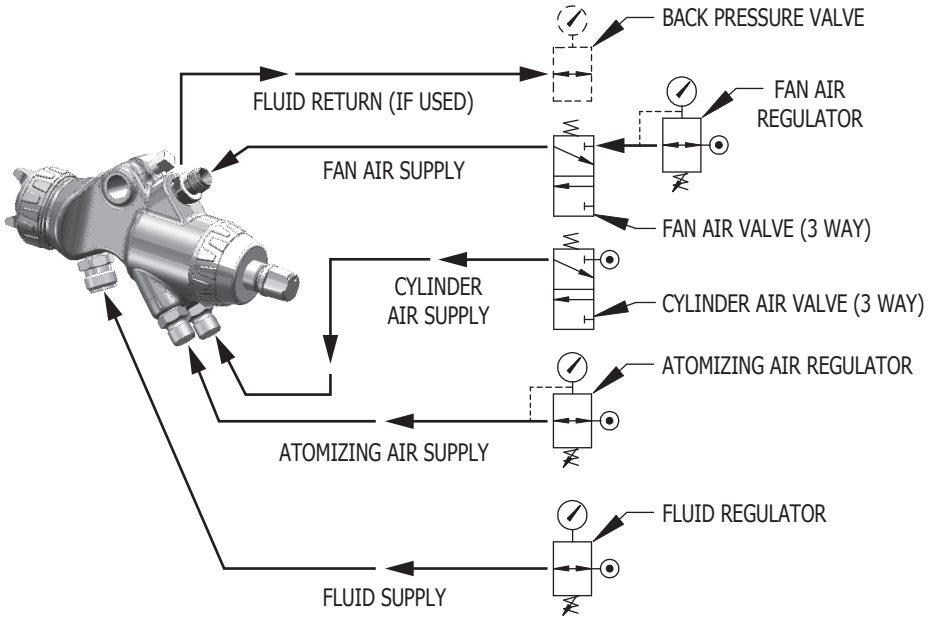

## NUMBERING SYSTEM FOR BINKS AUTOMATIC "TROPHY" SERIES SPRAY GUNS

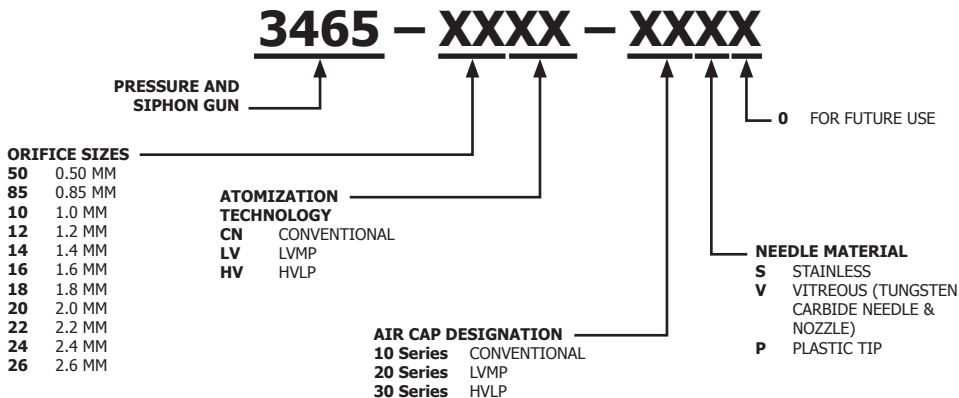

See charts on pages 9-10 for complete gun assemblies.

**CHART 2:  
STAINLESS STEEL FEATHERING  
NEEDLES AND NOZZLES – OPTIONAL**

FEATHERING NEEDLE PART NO.	MARKING ON THE NEEDLE	MATCHING NOZZLE P/N (ORIFICE SIZE)
47-6864	I IIII	45-11050-12 1.2MM (.047")
47-6865	II IIII	45-11050-14 1.4MM (.055")
47-6866	III IIII	45-11050-18 1.8MM (.071")

**CHART 3:  
TUNGSTEN CARBIDE  
NOZZLES AND NEEDLES**

NOZZLE SIZE	TC NOZZLE P.N.	TC NEEDLE P.N.
1.4 MM (.055")	45-11080-14	47-6861
1.8 MM (.071")	45-11080-18	47-6861
2.2 MM (.086")	45-11080-22	47-6861
2.6 MM (.102")	45-11080-26	47-6861

**CHART 4:  
STAINLESS STEEL (HARDENED)  
FLUID NOZZLES – STD.**

STAINLESS FLUID NOZZLE ORIFICE SIZE	FLUID NOZZLE PART NUMBER
.020"	.50 mm 45-11050-50
.035"	.85 mm 45-11050-85
.039"	1.0 mm 45-11050-10
.047"	1.2 mm 45-11050-12
.055"	1.4 mm 45-11050-14
.063"	1.6 mm 45-11050-16
.071"	1.8 mm 45-11050-18
.079"	2.0 mm 45-11060-20
.087"	2.2 mm 45-11060-22
.102"	2.6 mm 45-11060-26

**CHART 5:  
TEST AIR CAP KITS –  
OPTIONAL**

CONVENTIONAL	
54-6140-K	11-C KIT
54-6141-K	12-C KIT
54-6142-K	14-C KIT
LVMP	
54-6146-K	22-L KIT
54-6147-K	23-L KIT
54-6148-K	24-L KIT
54-6149-K	25-L KIT
HVLP	
54-6151-K	31-H KIT – HVLP
54-6152-K	32-H KIT – HVLP
54-6153-K	33-H KIT – HVLP
54-6154-K	39-H KIT – HVLP



## BINKS "TROPHY" SERIES AUTOMATIC SPRAY GUN NEEDLE AND NOZZLE SELECTION GUIDE

### CHART 6: CONVENTIONAL GUN SET-UPS

TYPE OF FLUID TO BE SPRAYED	COMPLETE GUN ASSEMBLY PART NUMBER	FLUID NOZZLE AND AIR CAP
<b>THIN</b> 5-25 CENTIPOISE <b>15-19 sec. Zahn 2 cup</b> wash primers, dyes, stains, solvents, water, inks, sealers, laquers, lubricants, zinc chromates, acrylics	3465-10CN-11S0	1.0 mm (.039") X 11C
	3465-12CN-11S0	1.2 mm (.047") X 11C
	3465-14CN-11S0	1.4 mm (.055") X 11C
	3465-16CN-11S0	1.6 mm (.063") X 11C
	3465-16CN-12S0	1.6 mm (.063") X 12C
<b>MEDIUM</b> 25-70 CENTIPOISE <b>20-30 sec. Zahn 2 cup</b> synthetic enamels, varnishes, shellacs, fillers, primers, epoxies, urethanes, lubricants, wax emulsions, enamels	3465-12CN-11S0	1.2 mm (.047") X 11C
	3465-14CN-11S0	1.4 mm (.055") X 11C
	3465-16CN-11S0	1.6 mm (.063") X 11C
	3465-16CN-12S0	1.6 mm (.063") X 12C
	3465-18CN-11S0	1.8 mm (.070") X 11C
	3465-20CN-14S0	2.0 mm (.079") X 14C
<b>HEAVY</b> 70-160 CENTIPOISE <b>31-66 sec. Zahn 2 cup</b>	3465-16CN-11S0	1.6 mm (.063") X 11C
	3465-16CN-12S0	1.6 mm (.063") X 12C
	3465-18CN-11S0	1.8 mm (.070") X 11C
	3465-20CN-14S0	2.0 mm (.079") X 14C
	3465-22CN-14S0	2.2 mm (.087") X 14C
<b>ADHESIVES</b> water based vinyl glues, solvent based neoprenes, contact cements	3465-20CN-14S0	2.0 mm (.079") X 14C
	3465-22CN-14S0	2.2 mm (.087") X 14C
<b>MOLD RELEASE</b>	3465-12CN-11S0	1.2 mm (.047") X 11C
<b>CERAMICS</b> abrasive materials, glazes, engobes, porcelain enamel	3465-14CN-14V0	1.4 mm (.055") X 14C ■
	3465-18CN-14V0	1.8 mm (.070") X 14C ■
	3465-22CN-14V0	2.2 mm (.087") X 14C ■
	3465-26CN-14V0	2.6 mm (.102") X 14C ■
<b>NON-STICK COATINGS</b>	3465-10CN-11S0	1.0 mm (.039") X 11C
	3465-12CN-11S0	1.2 mm (.047") X 11C
<b>HAMMERS</b>	3465-14CN-11S0	1.4 mm (.055") X 11C
	3465-16CN-11S0	1.6 mm (.063") X 11C
	3465-16CN-12S0	1.6 mm (.063") X 12C
<b>WRINKLE ENAMELS</b>	3465-14CN-11S0	1.4 mm (.055") X 11C
	3465-16CN-11S0	1.6 mm (.063") X 11C
<b>ZINC RICH COATINGS</b>	3465-22CN-14V0	2.2 mm (.087") X 14C ■

■ Tungsten carbide needle and nozzle set-ups    ● Plastic needle tip set-ups

## BINKS "TROPHY" SERIES AUTOMATIC SPRAY GUN NEEDLE AND NOZZLE SELECTION GUIDE

### CHART 7: LVMP GUN SET-UPS

TYPE OF FLUID TO BE SPRAYED	COMPLETE GUN ASSEMBLY PART NUMBER	FLUID NOZZLE AND AIR CAP
<b>THIN</b> 5-25 CENTIPOISE 15-19 sec. Zahn 2 cup	3465-85LV-2250	0.85 mm (.034") X 22L
	3465-10LV-2250	1.0 mm (.039") X 22L
	3465-12LV-2350	1.2 mm (.047") X 23L
	3465-14LV-2350	1.4 mm (.055") X 23L
	3465-14LV-2450	1.4 mm (.055") X 24L
	3465-85LV-2550	0.85 mm (.034") X 25L
	3465-10LV-2550	1.0 mm (.039") X 25L
<b>MEDIUM</b> 25-70 CENTIPOISE 20-30 sec. Zahn 2 cup	3465-12LV-2350	1.2 mm (.047") X 23L
	3465-14LV-2350	1.4 mm (.055") X 23L
	3465-14LV-2450	1.4 mm (.055") X 24L
	3465-16LV-2350	1.6 mm (.063") X 23L
	3465-14LV-2550	1.4 mm (.055") X 25L
	3465-18LV-2550	1.8 mm (.070") X 25L

### CHART 9: ROUND SPRAY GUN SET-UPS

TYPE OF FLUID TO BE SPRAYED	COMPLETE GUN ASSEMBLY PART NUMBER	FLUID NOZZLE AND AIR CAP
<b>THIN</b> 5-25 CENTIPOISE 15-19 sec. Zahn 2 cup	3465-12CN-1650	1.2 mm (.047") X 16
<b>MEDIUM</b> 25-70 CENTIPOISE 20-30 sec. Zahn 2 cup	3465-12CN-1650	1.2 mm (.047") X 16

### CHART 8: HVLP GUN SET-UPS

TYPE OF FLUID TO BE SPRAYED	COMPLETE GUN ASSEMBLY PART NUMBER	FLUID NOZZLE AND AIR CAP
<b>THIN</b> 5-25 CENTIPOISE 15-19 sec. Zahn 2 cup	3465-85HV-3350	0.85 mm (.034") X 33H
	3465-85HV-31P0	0.85 mm (.034") X 31H ●
	3465-10HV-3350	1.0 mm (.039") X 33H
	3465-10HV-31P0	1.0 mm (.039") X 31H ●
	3465-10HV-3250	1.0 mm (.039") X 32H
	3465-12HV-3250	1.2 mm (.047") X 32H
	3465-12HV-31P0	1.2 mm (.047") X 31H ●
	3465-85HV-3950	0.85 mm (.034") X 39H
	3465-10HV-3950	1.0 mm (.039") X 39H
	3465-12HV-3950	1.2 mm (.047") X 39H
<b>MEDIUM</b> 25-70 CENTIPOISE 20-30 sec. Zahn 2 cup	3465-10HV-3250	1.0 mm (.039") X 32H
	3465-12HV-3250	1.2 mm (.047") X 32H
	3465-12HV-31P0	1.2 mm (.047") X 31H ●
	3465-14HV-3250	1.4 mm (.055") X 32H
	3465-14HV-31P0	1.4 mm (.055") X 31H ●
	3465-16HV-3250	1.6 mm (.063") X 32H
	3465-18HV-3250	1.8 mm (.070") X 32H
	3465-12HV-3950	1.2 mm (.047") X 39H
	3465-14HV-3950	1.4 mm (.055") X 39H
<b>HEAVY</b> 70-160 CENTIPOISE 31-66 sec. Zahn 2 cup	3465-14HV-3250	1.4 mm (.055") X 32H
	3465-14HV-31P0	1.4 mm (.055") X 31H ●
	3465-16HV-3250	1.6 mm (.063") X 32H
	3465-18HV-3250	1.8 mm (.070") X 32H

■ Tungsten carbide needle and nozzle set-ups    ● Plastic needle tip set-ups

## BINKS "TROPHY" SERIES AUTOMATIC SPRAY GUN AIR CAP AND FLUID NOZZLE SELECTION CHARTS

### CHART 10: CONVENTIONAL AIR CAP AND FLUID NOZZLE SELECTION CHART

Air Cap	Air Cap Part No.	Spray Pattern Range	CFM @ 30 PSI	CFM @ 50 PSI	CFM @ 70 PSI	Fluid Nozzle	Typical Coatings
11-C	46-6500	8 – 12"	9.8	14.2	18.7	45-11050 series, 1.0 mm – 1.8 mm	Stains, Primers, Lacquers, Enamels, Acrylics, Reduced Latex
12-C	46-6501	4 – 12"	8.3	12.1	14.2	45-11050 series, 1.0 mm – 1.8 mm	Lacquers, Enamels, Top Coats, Low Viscosity Adhesives
14-C	46-6503	8 – 14"	17.0	24.4	31.2	45-11060 series, 2.0 mm – 2.6 mm or 45-11080 Tungsten Carbide Series (VT), 1.4 mm – 2.6 mm	Zinc Rich, Adhesives, Glazes, Engobes, Ceramics, Porcelain Enamels

### CHART 11: LVMP – LOW VOLUME MEDIUM PRESSURE AIR CAP AND FLUID NOZZLE SELECTION CHART

Air Cap	Air Cap Part No.	Spray Pattern Range	CFM @30 PSI Gun Inlet (Dynamic)	Fluid Nozzle	Typical Coatings
22-L	46-6510	4 – 12"	11.2	45-11050 series, 0.5 mm – 1.6 mm	Stains, Primers, Lacquers, Enamels, Acrylics, Reduced Latex
23-L	46-6511	4 – 12"	10.6	45-11050 series, 1.0 mm – 1.8 mm	Lacquers, Enamels, Top Coats, Low Viscosity Adhesives
24-L	46-6512	2 – 6"	14.3	45-11050 series, 0.5 mm – 1.8 mm	Small Pattern Applications of Stains, Enamels, Lacquers, Acrylics
25-L	46-6513	4 – 15"	14.7	45-11050 series, 0.85 mm – 1.8 mm	Dyes, Stains, Toners, Enamels, Lacquers, Primers, Urethanes, Solvent Coatings, Waterborne Coatings

### CHART 12: HVLP – HIGH VOLUME LOW PRESSURE AIR CAP AND FLUID NOZZLE SELECTION CHART

Air Cap	Air Cap Part No.	Spray Pattern Range	SCFM @ 10 PSI Cap Pressure (Dynamic)	Gun Inlet PSI @ 10 PSI at Air Cap (Dynamic)	Fluid Nozzle	Typical Coatings
31-H	46-6517	8 – 12"	10.5	17	45-11050 series, .85 mm – 1.8 mm	Stains, Low Viscous Enamels
32-H	46-6518	8 – 18"	15.5	24	45-11050 series, .85 mm – 1.8 mm	Lacquers, Enamels, Multi-Colors, Multi-Spec, Nonstick Coatings, Cut-Latex
33-H	46-6519	8 – 12"	11.0	16	45-11050 series, .85 mm – 1.6 mm	Stains, Lacquers, Enamel, Multi-Color, Multi-Spec, Nonstick Coatings
39-H	46-6525	4 – 12"	8.7	14	45-11050 series, .85 mm – 1.6 mm	Dyes, Stains, Toners, Enamels, Lacquers, Primers, Urethanes, Solvent Coatings, Waterborne Coatings

## BINKS "TROPHY" SERIES AUTOMATIC SPRAY GUN AIR CAP AND FLUID NOZZLE SELECTION CHARTS

### CHART 13: ROUND SPRAY AIR CAP AND FLUID NOZZLE SELECTION CHART

Air Cap	Air Cap Part No.	Spray Pattern Range	CFM @ 30 PSI	CFM @ 50 PSI	CFM @ 70 PSI	Fluid Nozzle	Typical Coatings
16	46-6505	2 – 4"	5.6	7.8	10.5	45-11050 series, 1.0 mm – 1.8 mm	Lacquers, Enamels

### SETUP FOR SPRAYING

#### CONNECTING GUN TO MATERIAL HOSE

Gun should be connected by a suitable length of 3/8" diameter material hose fitted with a connector with a 3/8" NPS(f) nut at gun end. 1/4" diameter hose is recommended for use with low viscosity materials. (Fluid hoses of different composition are available for special fluids. See Binks hose catalog for hose selection.)

or 3/8" diameter air hose fitted with a connector and a 1/4" NPS(f) nut at gun end.

#### CONNECTING GUN TO CYLINDER AIR

Gun should be connected with 3/16" I.D. or 1/8" I.D. air hose of shortest length possible with 1/4" NPS(f) connector. Cylinder air must be connected to a 3-way manual air valve or 3-way solenoid valve to operate properly.

#### CONNECTING GUN TO ATOMIZING AIR

Gun should be connected by a suitable length of 5/16"

## OPERATING THE BINKS "TROPHY" SERIES AUTOMATIC SPRAY GUN

#### CONTROLLING THE MATERIAL FLOW

When fed from a pressure supply, an increase in the material pressure will increase the rate of flow. Correct fluid nozzle size insures correct material flow rate. If necessary, fluid flow can also be adjusted by adjusting the amount of needle travel. This is done by adjusting control knob (24) until the correct needle travel is achieved.

#### ADJUSTING THE SPRAY PATTERN

The width of the spray pattern is controlled by the side port control assembly (9). (See page 4). Turning this control clockwise until it is closed will give a round spray, turning it counterclockwise will widen the spray into a fan shape. The fan spray can be turned anywhere through 360° by positioning the air cap (5) relative to the gun. To effect this, loosen air cap assembly, position nozzle, then, re-tighten air cap assembly.

## MAINTENANCE

#### LUBRICATION

Monthly: Remove piston assembly (17) and lubricate the air cylinder chamber and needle valve spring with a coating of Gunners Mate (35). Also, lubricate side port control assembly (9) with oil.

#### REMOVAL OF PISTON

To remove the piston, first unscrew the end cap (15), remove two springs (16 & 23) and pull out the material needle (22). Remove the piston by screwing needle adjusting knob (24) into piston (21). See page 13 for details.

### CAUTION

**Never use lubricants containing silicone since these lubricants can cause finish defects. Binks Gunners Mate (35) is recommended.**

#### TO REPLACE NEEDLE SEAL AND GLAND ADAPTER IN FLUID INLET

See instructions on page 13.

## CLEANING

In certain states it is now against the law to spray solvents containing Volatile Organic Compounds (VOCs) into the atmosphere when cleaning a spray gun.

In order to comply with these new air quality laws Binks recommends one of the following two methods to clean your spray finishing equipment:

1. Spray solvent through the gun into a closed system. An enclosed unit, or spray gun cleaning station, condenses solvent vapors back into liquid form which prevents escape of VOCs into the atmosphere.
2. Place spray gun in a washer type container. This system must totally enclose the spray gun, cups, nozzles, and other parts during washing, rinsing, and draining cycles. This type of unit must be able to flush

solvent through the gun without releasing any VOC vapors into the atmosphere. Additionally, open containers for storage or disposal of solvent, or solvent-containing cloth or paper, used for surface preparation and clean-up may not be used. Containers shall be non-absorbent.

To clean the gun, flush the fluid lines with solvent and blow air through the air lines to make sure all the air passages are dry.

### CAUTION

**Never completely submerge the gun in solvent as this will dissolve the lubricating oil and dry out the seals.**

## TROUBLESHOOTING

### FAULTY SPRAY

A faulty spray may be caused by improper cleaning, dried materials around the fluid nozzle tip or in the air cap. Soak these parts in thinners that will soften the dried material and remove with a brush or cloth.

### CAUTION

**Never use metal instruments to clean the air or fluid nozzles. These parts are carefully machined and any damage to them will cause faulty spray.**

If either the air cap assembly (5) or fluid nozzle (7) are damaged, these parts must be replaced before perfect spray can be obtained.

### INTERMITTENT SPRAY

If the spray flutters, it is caused by one of the following faults:

1. Insufficient material available. Check supply and replenish if necessary.
2. Loose fluid nozzle (2). Tighten, but without using undue force.
3. Leakage at gland adapter (35) and needle seal (36). Tighten packing nut (39) if loose, and replace gland adapter and needle seal if necessary.
4. Fluid connection insufficiently tight or dirt on cone faces of connection. Correct as necessary.
5. Leaking cylinder air and/or inadequate pressure.

## PISTON AND PACKING REMOVAL AND INSTALLATION PROCEDURES

(NOTE: DISASSEMBLY SHOWN – REVERSE SEQUENCE TO ASSEMBLE.)

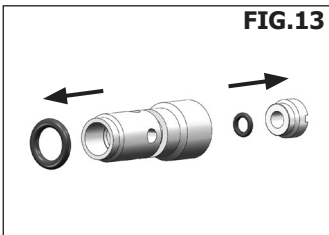
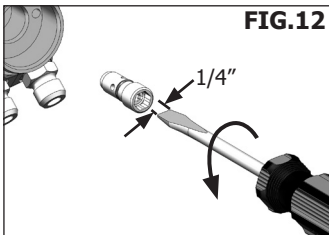
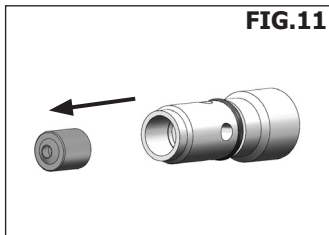
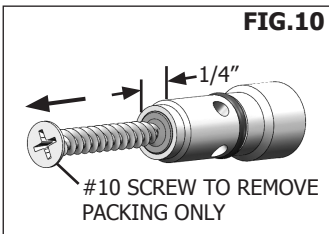
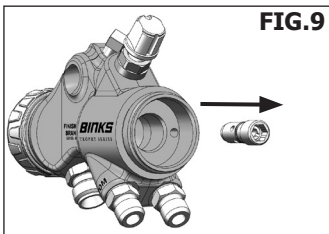
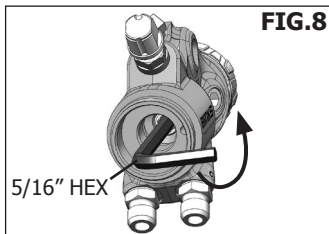
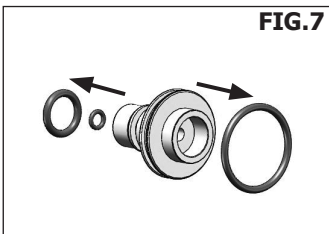
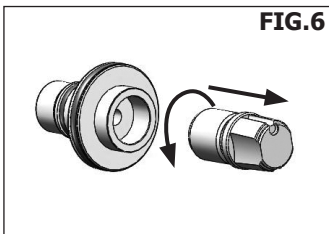
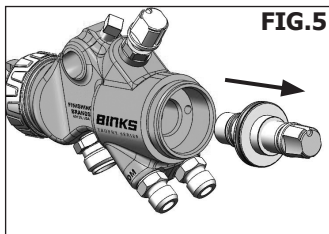
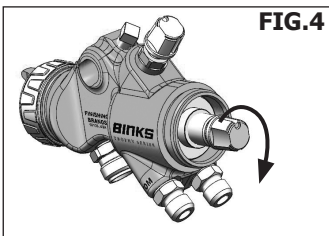
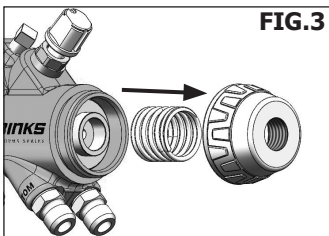
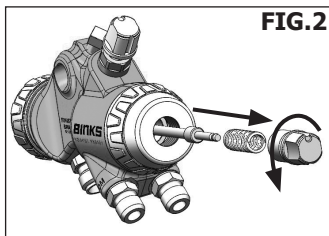
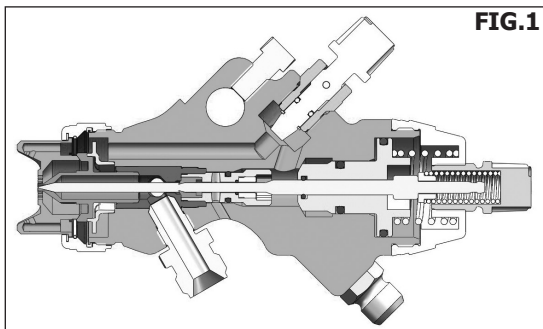



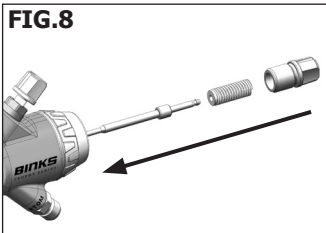
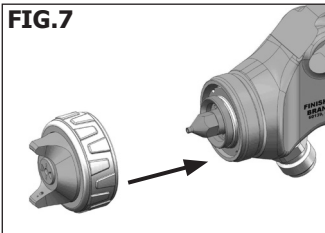
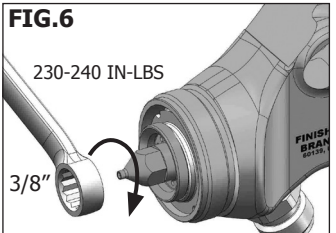
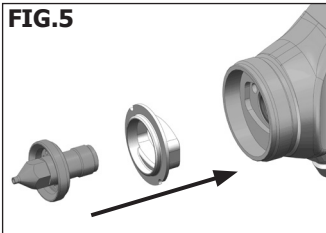
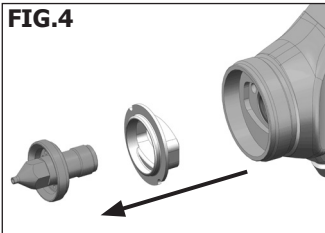
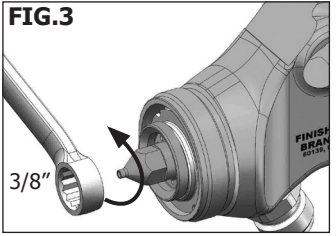
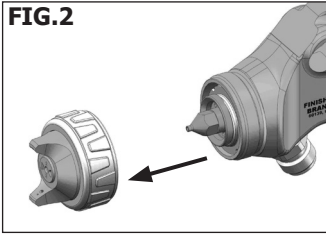
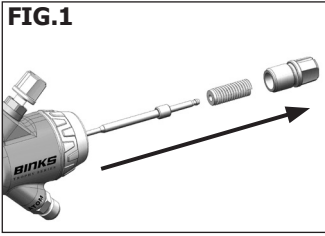

**BINKS "TROPHY" SERIES AUTOMATIC SPRAY GUN  
MAINTENANCE – FLUID NEEDLE, NOZZLE AND BAFFLE REMOVAL AND INSTALLATION**

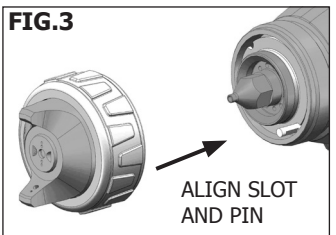
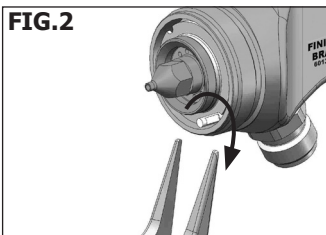
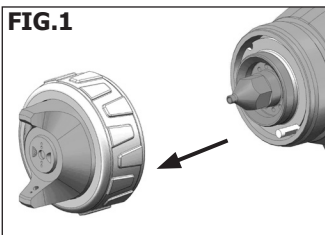

**BINKS "TROPHY" SERIES AUTOMATIC SPRAY GUN  
AIR CAP INDEX PIN (54-6184) INSTALLATION  
(OPTIONAL – 90° INCREMENTS INDEXING FEATURE)**



## TROUBLESHOOTING

CONDITION	CAUSE	CORRECTION
<b>Heavy top or bottom pattern</b> 	Horn holes plugged.	Clean. Ream with non-metallic point.
	Obstruction on top or bottom of fluid tip.	Clean.
	Cap and/or tip seat dirty.	Clean.
<b>Heavy right or left side pattern</b> 	Left or right side horn holes plugged.	Clean. Ream with non-metallic point.
	Dirt on left or right side of fluid tip.	Clean.
	Remedies for the top-heavy, bottom-heavy, right-heavy, and left-heavy patterns: 1. Determine if the obstruction is on the air cap or the fluid tip. Do this by making a test spray pattern. Then, rotate the cap one-half turn and spray another pattern. If the defect is inverted, obstruction is on the air cap. Clean the air cap as previously instructed. 2. If the defect is not inverted, it is on the fluid tip. Check for a fine burr on the edge of the fluid tip. Remove with #600 wet or dry sand paper. 3. Check for dried paint just inside the opening; remove by washing with solvent.	
<b>Heavy center pattern</b> 	Fluid flow too high for atomization air.	Balance air pressure and fluid flow. Increase spray pattern width with spreader adjustment valve.
	Material flow exceeds air cap's capacity.	Thin or lower fluid flow.
	Spreader adjustment valve set too low.	Adjust
	Atomizing pressure too low.	Increase pressure.
	Material too thick.	Thin to proper consistency.
<b>Split spray pattern</b> 	Atomization air pressure too high.	Reduce at transformer or gun.
	Fluid flow too low.	Increase fluid flow (increases gun handling speed).
	Spreader adjusting valve set too high.	Adjust.
<b>Jerky or fluttering spray</b> 	Loose or damaged fluid tip/seat. (Most common problem)	Tighten or replace.
	Material level too low.	Refill.
	Container tipped too far.	Hold more upright.
	Obstruction in fluid passage.	Backflush with solvent.
	Dry or loose fluid needle packing nut.	Lubricate or tighten.
<b>Unable to get round spray</b>	Spreader adjustment screw not seating properly.	Clean or replace.
	Air cap retaining ring loose.	Tighten.
<b>Will not spray</b>	No air pressure at gun.	Check air supply and air lines, blow out gun air passages.
	Fluid needle adjusting screw not open enough.	Open fluid needle adjusting screw.
<b>Paint bubbles in cup</b>	Fluid tip not tight.	Tighten tip.
<b>Fluid leaking or dripping from cup lid</b>	Cup lid loose.	Tighten lid.
	Dirty threads on cup or lid.	Clean.
	Cracked cup or lid.	Replace cup and lid.
<b>Starved spray pattern</b>	Inadequate material flow.	Back fluid adjusting screw out to first thread, or change to larger tip size.
	Low atomization air pressure.	Increase air pressure and rebalance gun.



## TROUBLESHOOTING

CONDITION	CAUSE	CORRECTION
<b>Excessive overspray</b>	Too much atomization air pressure.	Reduce pressure.
	Gun too far from work surface.	Adjust to proper distance.
	Improper stroking (arcing, gun motion too fast).	Move at moderate pace, parallel to work surface.
<b>Excessive fog</b>	Too much or too fast-drying thinner.	Remix properly.
	Too much atomization (air pressure.)	Reduce air pressure.
<b>Dry spray</b>	Air pressure too high.	Reduce air pressure.
	Gun tip too far from work surface.	Adjust to proper distance.
	Gun motion too fast.	Slow down.
	Gun out of adjustment.	Adjust.
<b>Fluid leaking from packing nut</b>	Packing nut loose.	Tighten, do not bind needle.
	Packing worn or dry.	Replace or lubricate.
<b>Fluid leaking or dripping from front of gun</b>	Packing nut too tight.	Adjust.
	Dry packing.	Lubricate.
	Fluid tip or needle worn or damaged.	Replace tip and needle.
	Foreign matter in tip.	Clean.
	Fluid needle spring broken.	Replace.
	Wrong size needle or tip.	Replace.
<b>Runs and sags</b>	Too much material flow.	Adjust gun or reduce fluid flow.
	Material too thin.	Mix properly or apply light coats.
	Gun tilted on an angle, or gun motion too slow.	Hold gun at right angle to work and adapt to proper gun technique.
<b>Thin, sandy coarse finish drying before it flows out</b>	Gun too far from surface.	Check distance. Normally approximately 8".
	Too much air pressure.	Reduce air pressure and check spray pattern.
	Improper thinner being used.	Follow paint manufacturer's mixing instructions.
<b>Thick, dimpled finish "orange peel"</b>	Gun too close to surface.	Check distance. Normally approximately 8".
	Too much material coarsely atomized.	Follow paint manufacturer's mixing instructions.
	Air pressure too low.	Increase air pressure or reduce fluid flow.
	Improper thinner being used.	Follow paint manufacturer's mixing instructions.
	Material not properly mixed.	Follow paint manufacturer's mixing instructions.
	Surface rough, oily, dirty.	Properly clean and prepare.

**ACCESSORIES**

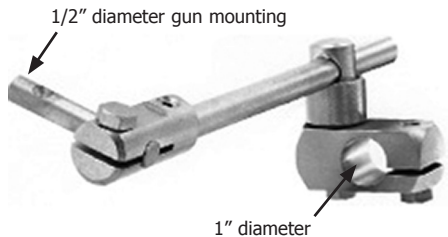

**54-380 MOUNTING BRACKET FOR AUTOMATIC GUNS**

- Steel bracket
- Adjustable to any position
- 18" bracket arm
- 1" diameter bracket clamp hole for attachment to facility hardware
- Shipping weight: 5 lbs.
- Part Sheet: 77-1185

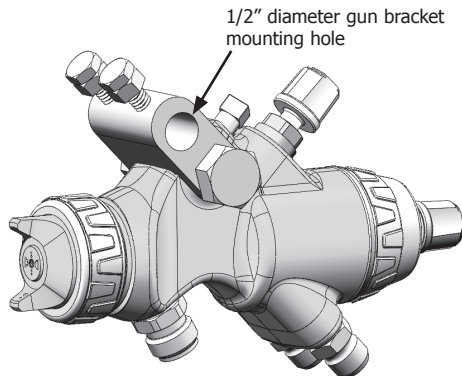

**54-6004 MOUNTING BRACKET FOR AUTOMATIC GUNS**

- Allows for quick gun removal without changing the gun's original spraying position



**54-6198 NEEDLE ADJUSTMENT STOP FOR AUTOMATIC GUNS**

**NOTES**

## WARRANTY POLICY

This product is covered by Carlisle Fluid Technologies' materials and workmanship limited warranty. The use of any parts or accessories, from a source other than Carlisle Fluid Technologies, will void all warranties. Failure to reasonably follow any maintenance guidance provided may invalidate any warranty.

For specific warranty information please contact Carlisle Fluid Technologies.

Carlisle Fluid Technologies is a global leader in innovative finishing technologies. Carlisle Fluid Technologies reserves the right to modify equipment specifications without prior notice.

DeVilbiss®, Ransburg®, ms®, BGK®, and Binks® are registered trademarks of Carlisle Fluid Technologies, Inc.

©2018 Carlisle Fluid Technologies, Inc.  
All rights reserved.

For technical assistance or to locate an authorized distributor, contact one of our international sales and customer support locations.

<b>Region</b>	<b>Industrial / Automotive</b>	<b>Automotive Refinishing</b>
Americas	Tel: 1-800-992-4657 Fax: 1-888-246-5732	Tel: 1-800-445-3988 Fax: 1-800-445-6643
Europe, Africa, Middle East, India	Tel: +44 (0)1202 571 111 Fax: +44 (0)1202 573 488	
China	Tel: +8621-3373 0108 Fax: +8621-3373 0308	
Japan	Tel: +81 45 785 6421 Fax: +81 45 785 6517	
Australia	Tel: +61 (0) 2 8525 7555 Fax: +61 (0) 2 8525 7575	

For the latest information about our products, visit [www.carlisleleft.com](http://www.carlisleleft.com)